



GOLDBERG BROTHERS

BARN DOOR HARDWARE

2020 EDITION

MEDIUM-DUTY BARN DOOR PRODUCTS CATALOG



MP SERIES • BARNFOLD® SERIES • HIDDEN ROLLER SERIES • CP SERIES





GOLDBERG BROTHERS

BARN DOOR HARDWARE

MEDIUM-DUTY BARN DOOR PRODUCTS CATALOG

TABLE OF CONTENTS

MP SERIES		HIDDEN ROLLER SERIES	
Hardware sets, roller hangers	2	Hardware sets	8
Tracks	3	Roller hangers	8
Accessories	3	Tracks	8
Bypass hardware	5	Accessories	8
BARNFOLD® SERIES		PULL HANDLES, FLUSH PULLS, LATCHES	10
Hardware sets	5		
Roller hangers	6	CP SERIES	11
Tracks	6		
Accessories	7	Installation reference guides	12
		Warranty	16
		Color samples	inside back cover

Visit GoldbergBarnTrack.com for additional information and full installation instructions for most products.

Put your barn doors on the right track with the quality and convenience of Goldberg Brothers barn door hardware. Our award-winning products help make efficient use of any indoor living or working space. Our rustic, yet elegant, industrial design provides a bold focal point to any décor.

We designed our medium-duty barn door hardware product lines to offer superior style, performance, and economy when used with most medium- and light-weight interior doors. Designed to fit the most commonly used door sizes, MP Series products are a better value and outperform inferior, imported hardware. All medium-duty hardware sets are factory equipped with silent rollers, and are available in 3 or more powder coat colors. All major steel components are made with up to 90% recycled materials.

Goldberg Brothers products have been proudly made in USA since 1897. Our commitment to quality, craftsmanship and value is built into everything we do.

MP SERIES: HARDWARE SETS, ROLLER HANGERS

MP SERIES

MP J-Strap Hardware Set (complete less track)



for 1 3/8" to 1 3/4" thick doors 6008HJ-*

Set includes:

- 2 J-strap hangers with bolts and nuts
- wall mounting hardware set (6 lag bolts, spacers and washers)
- 2 track stops
- 2 anti-jump blocks with screws
- floor guide (T) with screws
- felt pads
- rubber bumper bands

MP J-Top Mount Hardware Set (complete less track)



for most common door sizes 6008HJTM-*

Set includes:

- 2 J-top mount hangers with screws
- wall mounting hardware set (6 lag bolts, spacers and washers)
- 2 track stops
- 2 anti-jump blocks with screws
- floor guide (T) with screws
- felt pads
- rubber bumper bands

MP J-Strap Hanger (1 each, with bolts and nuts)



1 1/2" x 10" x 1 1/2"

6008RJ-*

MP J-Top Mount Hanger (1 each, with screws)



3 1/2" x 4 1/2" x 1 1/2"

6008RJTM-*

MP Straight Strap Hardware Set (complete less track)



for 1 3/8" to 1 3/4" thick doors 6008H-*

Set includes:

- 2 straight strap hangers with bolts and nuts
- wall mounting hardware set (6 lag bolts, spacers and washers)
- 2 track stops
- 2 anti-jump blocks with screws
- floor guide (T) with screws
- felt pads
- rubber bumper bands

MP Top Mount Hardware Set (complete less track)



for most common door sizes 6008HTM-*

Set includes:

- 2 straight top mount hangers with screws
- wall mounting hardware set (6 lag bolts, spacers and washers)
- 2 track stops
- 2 anti-jump blocks with screws
- floor guide (T) with screws
- felt pads
- rubber bumper bands

MP Straight Strap Hanger (1 each, with bolts and nuts)



1 1/2" x 9 1/2" x 1 1/4"

6008R-*

MP Top Mount Hanger (1 each, with screws)



3 1/2" x 4" x 1 1/2"

6008RTM-*

Replace the * in the product's SKU with the code for the desired color. See inside back cover for color samples and codes.

MP SERIES: HARDWARE SETS, ROLLER HANGERS, TRACKS, ACCESSORIES

MP Horseshoe Hardware Set (complete less track)



weight limit 250 lb

for 1 3/8" to 1 3/4" thick doors	6008H2-*
Set includes:	
<ul style="list-style-type: none"> • 2 horseshoe hangers with bolts and nuts • wall mounting hardware set (6 lag bolts, spacers and washers) • 2 track stops • 2 anti-jump blocks with screws • floor guide (T) with screws • felt pads • rubber bumper bands 	

MP Horseshoe Hanger (1 each, with bolts and nuts)



6" x 8 3/4" x 1 1/4"

	6008R2-*
--	----------

Wall Mounting Kit (set of 6 lag bolts, 6 washers, 18 spacers)



	6008M-*
--	---------

Track Connecting Plate (1 each)



2 3/4" x 1 1/8"

	6008C-*
--	---------

Track Stop (1 each, with rubber bumper band)



1 1/2" x 1 1/2" x 3/4"

	6008S-*
--	---------

MP Series Track



1 1/2" x 3/16"

4' (for 2'0" wide door)		6008T4-*
4'8" (for 2'4" wide door)		6008T48-*
5' (for 2'6" wide door)		6008T5-*
5'4" (for 2'8" wide door)		6008T54-*
6' (for 3'0" wide door)		6008T6-*
7' (for 3'6" wide door)		6008T7-*
8' (for 4'0" wide door)		6008T8-*
biparting 6' (for pair of 1 1/2' wide doors)		6008T6P-*
biparting 8' (for pair of 2' wide doors)		6008TRP-*
Long lengths	8'1" to 10'	6008T100-*
	10'1" to 16'	6008T160-*
Custom cut service (Order a standard track length longer than what you need. We will cut it down to the correct size for you.)	1 to 5 pieces	6001CCT1
	6 to 11 pieces	6001CCT2
	12 or more pieces	6001CCT4

Soft Stop (set of 2, with triggers and screws)



11" between center points of lag bolts (for tracks up to 7')	6008SOFT11
17" between center points of lag bolts (for tracks up to 8'+)	6008SOFT17

Hollow Core Support Plate (set of 2)



1 1/2" x 5" each

	6008HCP-*
--	-----------

Adjustable Track Stop (1 each, with set screws and rubber bumper band)



5/8" x 1 1/8" x 1"

	6008SC-*
--	----------

MP SERIES

Replace the * in the product's SKU with the code for the desired color. See inside back cover for color samples and codes.

MP SERIES: ACCESSORIES

MP SERIES

BARNFOLD® SERIES

Anti-Jump Blocks (clear acrylic, set of 2, with screws and felt pads)



1"×1"×¼" each

6008J

Rubber Bumper Band (1 each)

1½"×½"



Black

6008833

Floor T-Guide (aluminum, 1 each, with screws)

1½"×1½"×1"



6001G-*

T-Guide, 24" Long (aluminum, 1 each, with screws)

1½"×24"×1"



6001G2-*

Adjustable U-Guide (2 pieces, with screws)

⅞"×1"×1½" each



6001U-*

All-in-One Floor Guide (1 each, with screws)



6001GA-*

Sidewall Bracket (1 each, with screws and nuts)



standard	1½"×2"×2"	6001SW-*
long	1½"×2"×2½"	6001SWE-*
extra long	1½"×2"×3¼"	6001SWEX-*

Bumper/Stay Pads (set of 4, felt strips with adhesive back)

1"×⅜" each strip



White	6001BS-1
Black	6001BS-6

Hanger Stabilizer (Set of 2, with screws)



2¼"×1⅞" each

6001HS-*

Touch-up Paint (1 bottle, with brush)

0.6 fl oz



6001P-*

Replace the * in the product's SKU with the code for the desired color. See inside back cover for color samples and codes.

MP SERIES: BYPASS HARDWARE / BARNFOLD® SERIES: HARDWARE SETS

Bypass Adapter Kit (set of 6 adjustable brackets, with bolts and nuts)

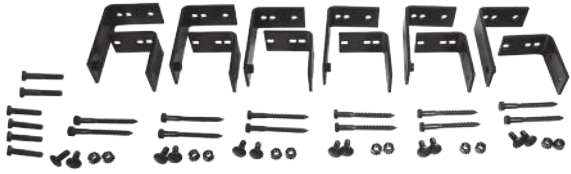

for 1 3/8" thick door with track up to 8'	6008BP3-*
for 1 1/4" thick door with track up to 8'	6008BP4-*

Bypass J-Guide and Push/Stops Kit (1 set, with screws)

(images not to scale)



for 1 3/8" thick door with track up to 8'	6008BPCK3-*
for 1 1/4" thick door with track up to 8'	6008BPCK4-*

Bypass Grab/Push Stops (set of 3, with screws)



6001PSX-*

Barnfold® J-Strap 2-Door Hardware Set

weight limit 125 lb

(track image not to scale)

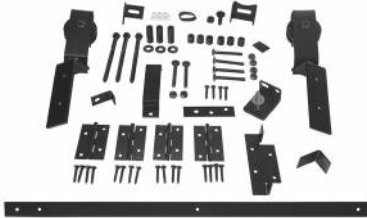

Set for 1 1/4" to 1 3/8" thick doors includes:

- left and right J-strap roller hangers
- one 4" pull handle
- four hinges
- one bottom pivot
- all necessary installation hardware

with 24" track (for 1'0" doors)	6007M2D24-*
with 28" track (for 1'2" doors)	6007M2D28-*
with 30" track (for 1'3" doors)	6007M2D30-*
with 32" track (for 1'4" doors)	6007M2D32-*
with 36" track (for 1'6" doors)	6007M2D36-*
with 42" track (for 1'9" doors)	6007M2D42-*
with 48" track (for 2'0" doors)	6007M2D48-*
without track	6007M2H-*

Bypass Single Add-On Set (1 each, with bolts, nuts, and spacer)



for 1 3/8" thick door and long track with more than 6 holes	6008BPS3-*
for 1 1/4" thick door and long track with more than 6 holes	6008BPS4-*

Bypass J-Guide (1 each, with screws)



for 1 3/8" thick door and long track with more than 6 holes	60013GX-*
for 1 1/4" thick door and long track with more than 6 holes	60014GX-*

Barnfold® J-Strap 4-Door Hardware Set

weight limit 250 lb

(track image not to scale)



Set for 1 1/4" to 1 3/8" thick doors includes:

- two pairs of left and right J-strap roller hangers
- two 4" pull handles
- eight hinges
- two bottom pivots
- all necessary installation hardware

with 48" (for 1'0" doors)	6007M4D48-*
with 56" (for 1'2" doors)	6007M4D56-*
with 60" (for 1'3" doors)	6007M4D60-*
with 64" (for 1'4" doors)	6007M4D64-*
with 72" (for 1'6" doors)	6007M4D72-*
with 84" (for 1'9" doors)	6007M4D84-*
with 96" (for 2'0" doors)	6007M4D96-*
without track	6007M4H-*

Replace the * in the product's SKU with the code for the desired color. See inside back cover for color samples and codes.

BARNFOLD® SERIES: HARDWARE SETS, ROLLER HANGERS, TRACKS

Barnfold® J-Top Mount 2-Door Hardware Set

weight limit 125 lb

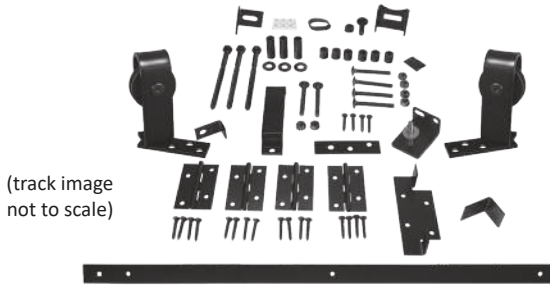

Set for 1¼" to 1¾" thick doors includes:

- left and right J top mount roller hangers
- one 4" pull handle
- four hinges
- one bottom pivot
- all necessary installation hardware

with 24" track (for 1'0" doors)	6007M2DTM24-*
with 28" track (for 1'2" doors)	6007M2DTM28-*
with 30" track (for 1'3" doors)	6007M2DTM30-*
with 32" track (for 1'4" doors)	6007M2DTM32-*
with 36" track (for 1'6" doors)	6007M2DTM36-*
with 42" track (for 1'9" doors)	6007M2DTM42-*
with 48" track (for 2'0" doors)	6007M2DTM48-*
without track	6007M2HTM-*

Barnfold® J-Top Mount 4-Door Hardware Set

weight limit 250 lb

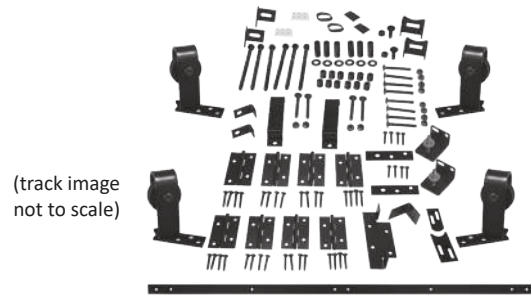

Set for 1¼" to 1¾" thick doors includes:

- two pairs of left and right J top mount roller hangers
- two 4" pull handles
- eight hinges
- two bottom pivots
- all necessary installation hardware

with 48" (for 1'0" doors)	6007M4DTM48-*
with 56" (for 1'2" doors)	6007M4DTM56-*
with 60" (for 1'3" doors)	6007M4DTM60-*
with 64" (for 1'4" doors)	6007M4DTM64-*
with 72" (for 1'6" doors)	6007M4DTM72-*
with 84" (for 1'9" doors)	6007M4DTM84-*
with 96" (for 2'0" doors)	6007M4DTM96-*
without track	6007M4HTM-*

BARNFOLD® SERIES

Barnfold® J-Strap Hanger (1 each, with bolts and nuts)

1½"×10"×1½"



Left side	6007MRL-*
Right side	6007MRR-*

Barnfold® J-Top Mount Hanger (1 each, with screws)

3½"×4½"×1½"



Left side	6007MRLTM-*
Right side	6007MRRTM-*

Barnfold® 2-Door Track



24" track (for 1'0" doors)	6007T224-*
28" track (for 1'2" doors)	6007T228-*
30" track (for 1'3" doors)	6007T230-*
32" track (for 1'4" doors)	6007T232-*
36" track (for 1'6" doors)	6007T236-*
42" track (for 1'9" doors)	6007T242-*
48" track (for 2'0" doors)	6007T248-*

Barnfold® 4-Door Track



48" track (for 1'0" doors)	6007T448-*
56" track (for 1'2" doors)	6007T456-*
60" track (for 1'3" doors)	6007T460-*
64" track (for 1'4" doors)	6007T464-*
72" track (for 1'6" doors)	6007T472-*
84" track (for 1'9" doors)	6007T484-*
96" track (for 2'0" doors)	6007T496-*

Replace the * in the product's SKU with the code for the desired color. See inside back cover for color samples and codes.

BARNFOLD® SERIES: ACCESSORIES

4-Door Alignment Plates (1 set, with screws)



1¾"×¾" and 2"×1"

6007BFA-*

2-door Adapter Kit for 1½" to 1¾" doors



6007M4K2-*

4-door Adapter Kit for 1½" to 1¾" doors



6007M4K4-*

Barnfold® Bottom Pivot Kit (1 set, with screws)

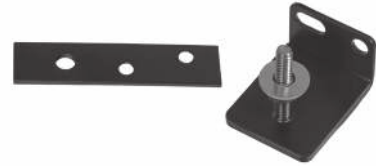

for 1¼" and 1⅜" thick doors

6007MP-*

for 1½"-1¾" thick doors

6007MP4-*

2-door Extension Kit (3 bolts, 3 spacers)



½" extension

6007M2E-*

⅞" extension

6007M2EX-*

4-door Extension Kit (6 bolts, 6 spacers)



½" extension

6007M4E-*

⅞" extension

6007M4EX-*

Fixed Hanger Stop (1 each)



1⅓"×1½"×¾"

6007MS-*

Adjustable Hanger Stop (1 each)



1½"×1½"×¾"

6007MSA-*

Anti-jump Block (1 each)



¾"×⅞"×⅝"

6007MJ-*

Hinge (1 each, with screws)



1⅝"×2½"

6007MH-*

BARNFOLD® SERIES

Replace the * in the product's SKU with the code for the desired color. See inside back cover for color samples and codes.

HIDDEN ROLLER SERIES: HARDWARE SETS, ROLLER HANGERS, TRACKS, ACCESSORIES

Single Roller Hardware Set (complete less track)

weight limit 125 lb



for most doors at least 1" thick doors

6010H1-*

Set includes:

- 2 single hidden roller hangers with screws
- wall mounting hardware set (6 lag bolts, spacers and washers)
- 2 track stops
- floor guide (T) with screws
- felt pads
- rubber bumper bands

Double Roller Hardware Set (complete less track)

weight limit 250 lb



for most doors at least 1" thick doors

6010H2-*

Set includes:

- 2 double hidden roller hangers with screws
- wall mounting hardware set (6 lag bolts, spacers and washers)
- 2 track stops
- floor guide (T) with screws
- felt pads
- rubber bumper bands

Single Hidden Roller Hanger (1 each, with screws)



3¼" x 3⅞" x ¾"

6010R1-*

Hidden Roller Series Track (same track used with MP Series)



1½" x ⅜"

4' (for 2'0" wide door)		6008T4-*
4'8" (for 2'4" wide door)		6008T48-*
5' (for 2'6" wide door)		6008T5-*
5'4" (for 2'8" wide door)		6008T54-*
6' (for 3'0" wide door)		6008T6-*
7' (for 3'6" wide door)		6008T7-*
8' (for 4'0" wide door)		6008T8-*
biparting 6' (for pair of 1½' wide doors)		6008T6P-*
biparting 8' (for pair of 2' wide doors)		6008TRP-*
Long lengths	8'1" to 10'	6008T100-*
	10'1" to 16'	6008T160-*
Custom cut service (Order a standard track length longer than what you need. We will cut it down to the correct size for you.)	1 to 5 pieces	6001CCT1
	6 to 11 pieces	6001CCT2
	12 or more pieces	6001CCT4

Double Hidden Roller Hanger (1 each, with screws)



5½" x 3⅞" x ¾"

6010R2-*

Wall Mount Kit (set of 6 lag bolts, washers, and spacers)



6010M-*

½" Extension Kit (set of 6 lag bolts and spacers)



6010E-*

Replace the * in the product's SKU with the code for the desired color. See inside back cover for color samples and codes.

HIDDEN ROLLER SERIES: ACCESSORIES

Track Stop (1 each)

1¼"×1½"



6010S-*

Track Connecting Plate (1 each)

2¾"×1⅞"



6008C-*

Floor T-Guide (aluminum, 1 each, with screws)

1½"×1½"×1"



6001G-*

T-Guide, 24" Long (aluminum, 1 each, with screws)

1½"×24"×1"



6001G2-*

Adjustable U-Guide (2 pieces, with screws)

7⁄8"×1"×1½" each



6001U-*

All-in-One Floor Guide (1 each, with screws)



6001GA-*

Sidewall Bracket (1 each, with screws and nuts)



standard	1½"×2"×2"	6001SW-*
long	1½"×2"×2½"	6001SWE-*
extra long	1½"×2"×3¼"	6001SWEX-*

Touch-up Paint (1 bottle, with brush)

0.6 fl oz



6001P-*

Bumper/Stay Pads (set of 4, felt strips with adhesive back)

1"×¾" each strip



White	6001BS-1
Black	6001BS-6

Rubber Bumper Band (1 each)

1½"×1½"



Black 6008833

Replace the * in the product's SKU with the code for the desired color. See inside back cover for color samples and codes.

FOR ALL BARN DOORS: PULL HANDLES, FLUSH PULLS, LATCHES

4" Pull Handle (1 each, with bolts and nuts)



See page 14 for dimensions

for 1¼" and 1½" thick doors	6007PH304-*
for 1½"- 1¾" thick doors	6007PH404-*

7" Pull Handle (1 each, with bolts, washers and nuts)



See page 14 for dimensions

for 1⅝" thick door	6001PH307-*
for 1¾" thick door	6001PH407-*
for 2¼" thick door	6001PH507-*
Universal (fits all 3)	6001PH007-*

11" Pull Handle (1 each, with bolts, washers and nuts)



See page 14 for dimensions

for 1¾" thick door	6001PH311-*
for 1¾" thick door	6001PH411-*
for 2¼" thick door	6001PH511-*
Universal (fits all 3)	6001PH011-*

16" Pull Handle (1 each, with bolts, washers and nuts)



See page 14 for dimensions

for 1¾" thick door	6001PH316-*
for 1¾" thick door	6001PH416-*
for 2¼" thick door	6001PH516-*
Universal (fits all 3)	6001PH016-*

3" Flush Pull (1 each, with face plate, dustbox and screws)



See page 15 for dimensions

6003FP03-*

6" Flush Pull (1 each, with face plate, dustbox and screws)



See page 15 for dimensions

6001FP06-*

12" Flush Pull (1 each, with face plate, dustbox and screws)



See page 15 for dimensions

6001FP12-*

Privacy Latch (1 each, with faceplate, dustbox, strike plate and screws)



See page 14 for dimensions

6001PL-*

Biparting Privacy Latch (1 set, with screws)



See page 15 for dimensions

6001PLP-*

Router Templates (set of 3, clear plastic)



flush pulls and privacy latch templates

6001TMP-2

HANDLES, PULLS, LATCHES

CP SERIES

Replace the * in the product's SKU with the code for the desired color. See inside back cover for color samples and codes.

CP SERIES BARN DOOR HARDWARE

A RETAIL-READY BARN DOOR HARDWARE SYSTEM IN ONE BOX

CP (Consumer Pack) SERIES from Goldberg Brothers is our everything-in-one-box solution that comes ready for retail store or contractor sales. Each package starts with our MP Series J-strap hardware set for a single door or a biparting pair. Choose from 3 powder coat colors. Then select any of five pack combinations ranging from basic essentials to premium extras.

Items marked with a ✓ are included in that pack.	BASE	BASE PLUS	ADJUSTABLE	ADJUSTABLE PLUS	PREMIUM
MP J-strap hardware	✓	✓	✓	✓	✓
Standard tracks: 4', 4'8", 5', 5'4", 6', 7', 8', biparting 6', biparting 8'	✓	✓			
Extended tracks: 63", 75", 99", biparting 75", biparting 99"			✓	✓	✓
Fixed stops	✓	✓			
Adjustable stops			✓	✓	✓
J-guide	✓	✓			
All-in-one guide			✓	✓	✓
6" flush pull & 7" pull handle					✓
Soft Stops		✓		✓	✓

Contact your wholesale distributor or Goldberg Brothers sales representative for more details and available CP Series product packs.

Available in 3 popular colors:

- SILVER METALLIC
- MATTE BLACK TEXTURE
- BRONZE TEXTURE

All track, hardware and accessories are packed in one box, for convenience your customers are sure to appreciate.



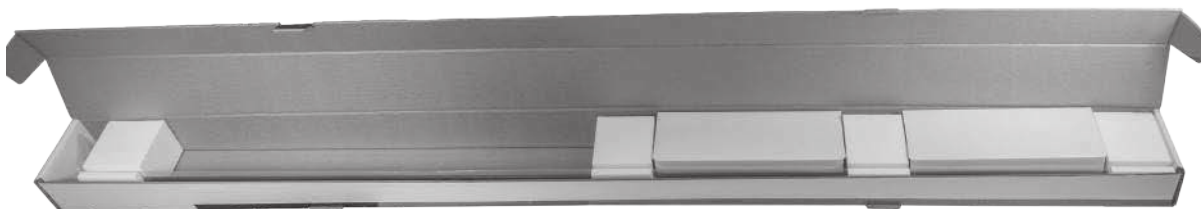

MP J-Strap hardware with DuPont™ Delrin® silent rollers. (200 lb limit)



HANDLES, PULLS, LATCHES

CP SERIES

Standard System Layouts

 T-guide location (floor mount)
 Connecting plate (track mount)
 Note: the use and position of connecting plates may vary, depending on track lengths



1 standard hardware set, 1 track = 2× the door width

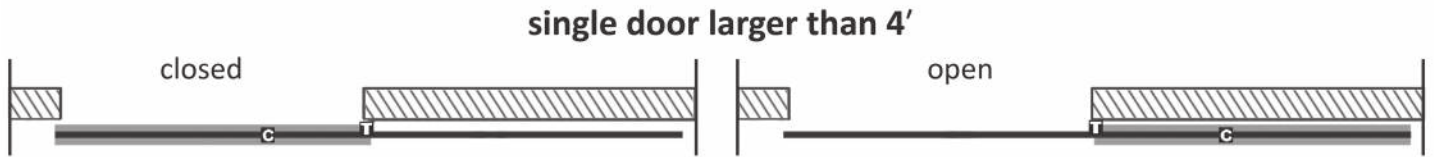

1 standard hardware set, 2 or 3 tracks = 2× the door width, connecting plate(s), extra wall mount kit(s)

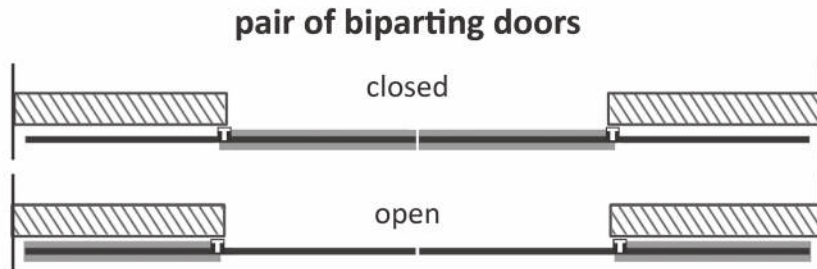

2 standard hardware sets, 2 tracks each 2× the door width, no connecting plate needed

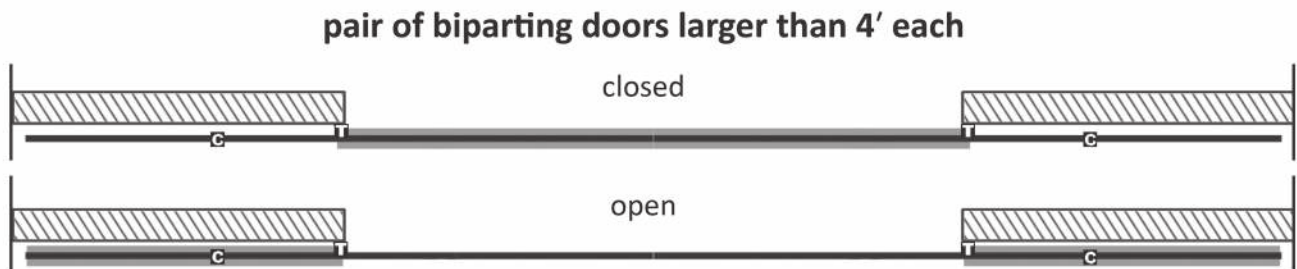



2 standard hardware sets, 4 or 6 tracks each = 2× the door width, connecting plate(s), extra wall mounting kit(s)

INSTALLATION REFERENCE GUIDES

Bypass System Layouts

2-door system, clear opening

 T-guide location (floor mount)
 J-guide location (on back door)



1 standard hardware set, 1 track = 2× the door width, 1 bypass hardware set, 1 or 2 tracks = 3× the door width. Add connecting plate and wall mounting kit for second track if needed. Add bypass spacer kit(s) if needed.

4-door system, clear opening

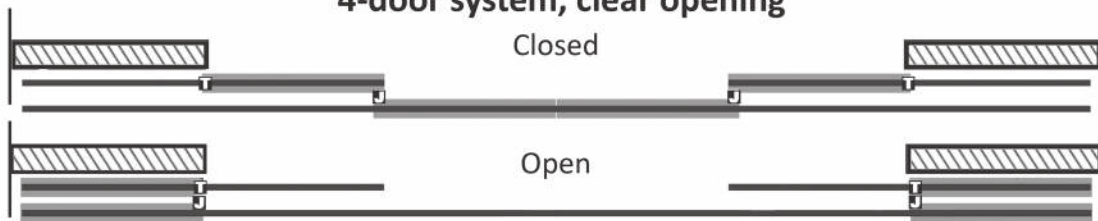

2 standard hardware sets, 2 tracks = 2× the door width, 2 bypass hardware sets, 2 or 4 tracks = 3× the door width. Add connection plate and wall mounting kit for over 2 tracks if needed. Add bypass spacer kit if needed.

2-door system, pass-through opening



1 standard hardware set, 1 bypass hardware set, 2 tracks = 2× the door width. Add 1 extra T-guide and bypass spacer kit if needed.

4-door system, pass-through opening

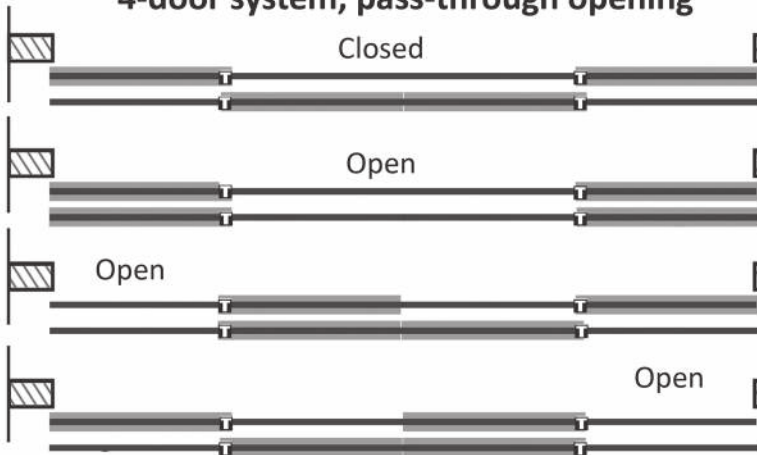

2 standard hardware sets, 2 bypass hardware sets, 4 tracks = 2× the door width. Add 2 extra T-guides and bypass spacer kits if needed.

3-door system, pass-through opening

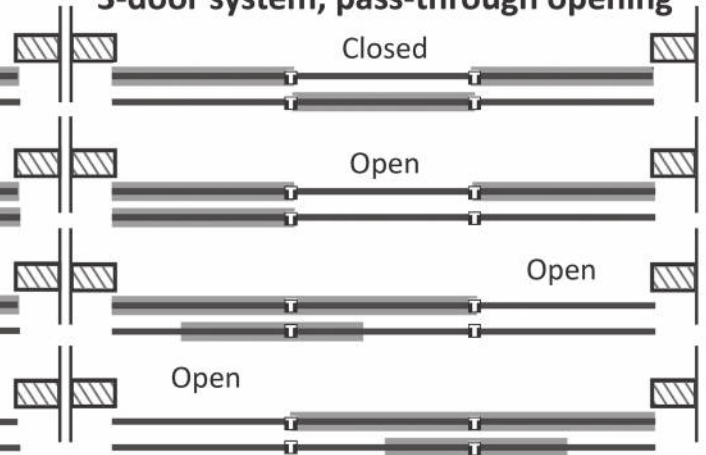

2 standard hardware sets, 1 bypass hardware set, 2 extra T-guides, 2 tracks = 3× the door width, 2 connecting plates, 1 wall mounting kit. Add bypass spacer kits if needed.

Pull Handles

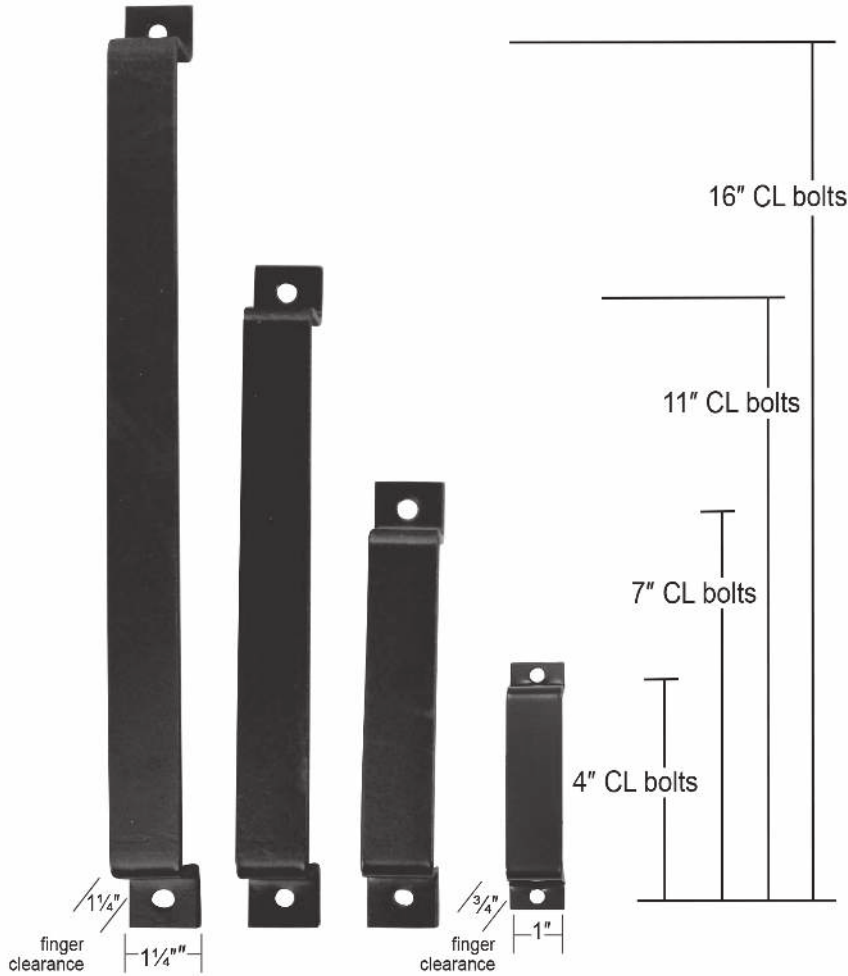

4" Pull Handle	1 1/4" to 1 3/8" 6007PH304-*	1 1/2" to 1 3/4" 6007PH404-*		
7" Pull Handle	1 3/8" 6001PH307-*	1 3/4" 6001PH407-*	2 1/4" 6001PH507-*	Universal 6001PH007-*
11" Pull Handle	1 3/8" 6001PH311-*	1 3/4" 6001PH411-*	2 1/4" 6001PH511-*	Universal 6001PH011-*
16" Pull Handle	1 3/8" 6001PH316-*	1 3/4" 6001PH416-*	2 1/4" 6001PH516-*	Universal 6001PH016-*

INSTALLATION
REFERENCE GUIDES

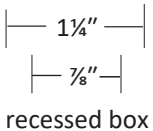
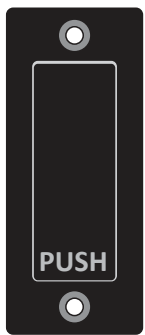

Privacy Latch

powder coated steel 6001PL-*
stainless steel 6005PL

3/16" x 1 1/4" solid bar stock

includes jamb strike & screws

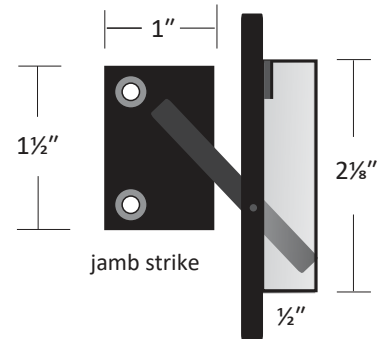

When door is on the outside of the room then the latch mounts to the door. When door is on the inside of the room then the latch mounts to the wall.

Replace the * in the product's SKU with the code for the desired color. Available in raw steel or 16 powder coat colors.

Flush Pulls

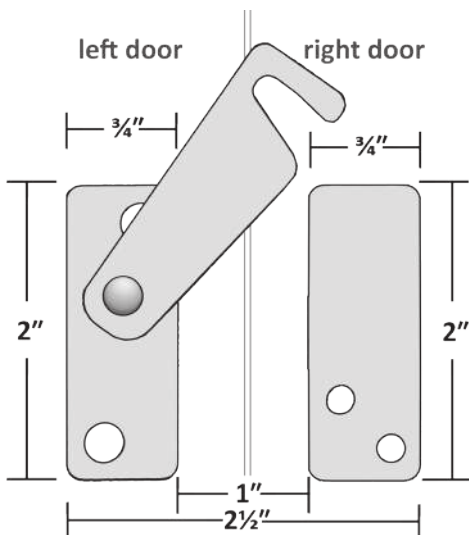
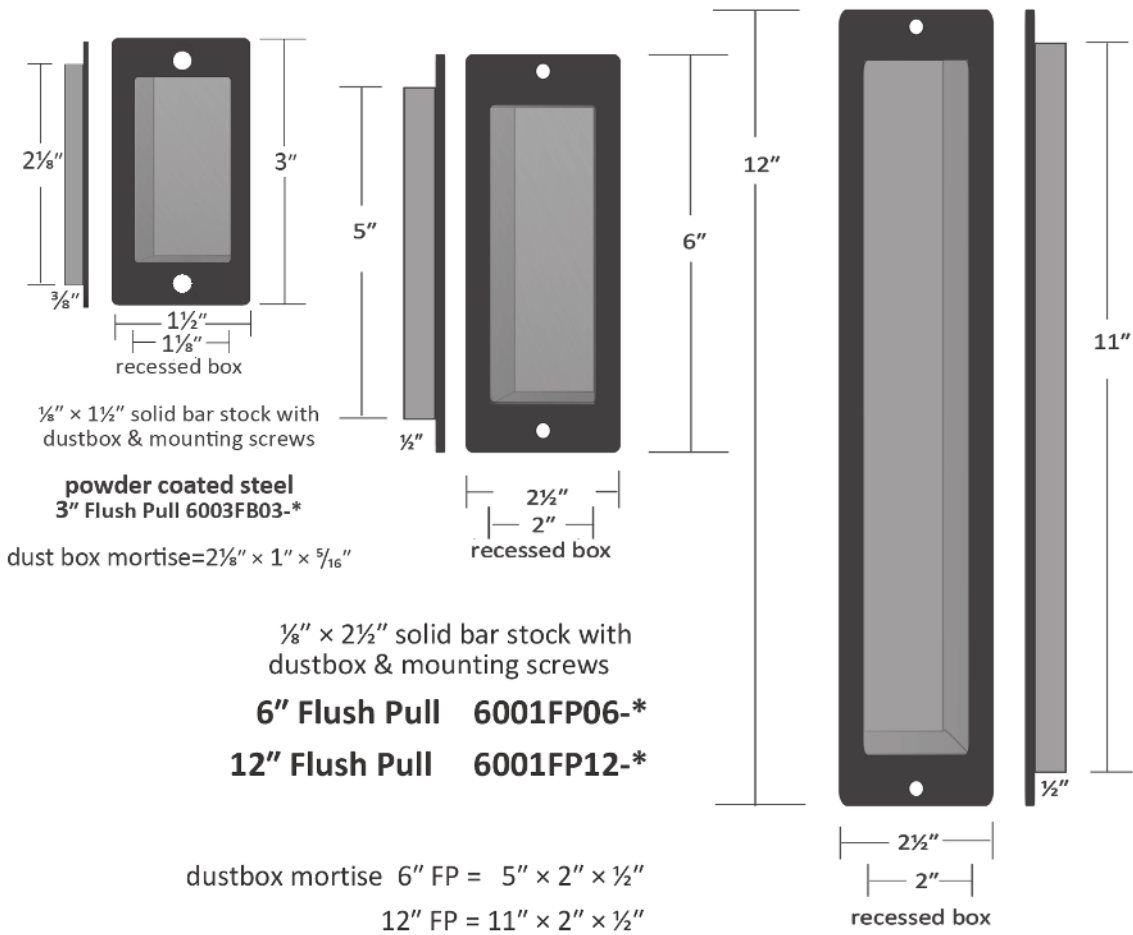

Privacy Latch for biparting doors

6001PLP-*
includes four mounting screws

Close doors and mount components with screwdriver while latch is in closed position.

Replace the * in the product's SKU with the code for the desired color. Available in raw steel or 16 powder coat colors.

WARRANTY

LIMITED LIFETIME MANUFACTURER'S WARRANTY

Goldberg Brothers warrants the functionality of its barn door hardware sets and tracks with a limited lifetime manufacturer's warranty for defective parts under normal installation and use. Warranty is subject to repair or replacement of defective components at manufacturer's discretion and does not include installation costs.

This warranty does not apply to the cosmetic condition of any products or components. Goldberg Brothers barn door hardware is sold as a rustic finished hardware and may develop scratches or other signs of wear during manufacturing or normal installation and use. Further, Goldberg Brothers does not warrant against any cosmetic imperfections in the steel parts that may be seen through the finish.

Certain accessories including but not limited to felt strips, rubber bumper bands, and Soft Stop motion buffer mechanisms have finite expected lifetimes due to wear and loss of tension or resilience during normal use over an extended period. Except for manufacturing defects that become apparent within 1 year of purchase, these accessories are not covered under this limited lifetime warranty. Replacement accessories may be purchased as needed from Goldberg Brothers retailers.

Except for stainless steel components, Goldberg Brothers barn door hardware products are not warranted against rust. Some rusting is possible on any raw steel or powder coated steel hardware installed outdoors or anywhere else that it may be exposed to high humidity, rain, snow, or running water.

This warranty does not include loss or defects caused by elements outside the control of Goldberg Brothers, Inc., such as natural disasters, weather, fire, water leakage, abuse, improper installation, or anything else deemed out of the control of Goldberg Brothers, Inc.



GOLDBERG BROTHERS
BARN DOOR HARDWARE

MEDIUM-DUTY BARN DOOR PRODUCTS COLORS

Products with SKUs that end with a dash and asterisk -* are available in multiple colors.
 Replace the asterisk * with the desired color code.

COLORS OPTIONS VARY BY PRODUCT LINE:

MP Series - Black, Silver Metallic, Arch Bronze









Barnfold® Series - raw steel and all 16 powder coat colors below







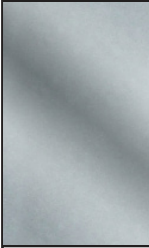

Hidden Roller Series - Black, Silver Metallic, Arch Bronze

CP Series - Silver Metallic, Black Matte Texture, Bronze Texture

Pull Handles, Flush Pulls, Latches - raw steel and all 16 powder coat colors below

Accessories with 6001 part numbers - raw steel and all 16 powder coat colors below

ECONOMY COLORS			STANDARD COLORS			UPGRADE COLORS	
							
RAW STEEL (not coated)	MATTE BLACK TEXTURE	BRONZE TEXTURE	BLACK	SILVER METALLIC	ARCH BRONZE	RUSTIC BROWN	JACOB'S GOLD
Color code "0"	Color code "MB"	Color code "BZ"	Color code "6"	Color code "1"	Color code "8"	Color code "4"	Color code "G"

DESIGNER COLORS								
								
PC CHROME	REGAL RED	ROCKET WHITE	BLUE RIBBON	FLINT GRAY TEXTURE	DARK GRAY TEXTURE	WHITE BRONZE TEXTURE	SILVER VEIN	COPPER VEIN

Use color code "D" and write the name of the designer color on the order form.

PLEASE NOTE:

- Due to variations in printers and display screens, all color representations above are approximate. Color sample cards are available. Ask your Goldberg Brothers sales representative for details.
- Raw steel does not have a protective coating. Rusting will occur.
- PC Chrome is a powder coat finish with a glossy, chrome-like appearance. It is not chrome plating.
- Steel components used with Matte Black Texture and Bronze Texture may have minor surface blemishes acquired during the manufacturing process. These superficial variations will be hidden by the powder coating and do not affect product performance.



GOLDBERG BROTHERS, INC.

- Award-winning barn door hardware
- Barnfold® folding barn door hardware
- Barn door edge wrap
- MClad® steel cabinet facing
- Movie-themed home decor products
- Movie theater projection ports and film reels
- Custom metal fabrication

10488 W. Centennial Rd., Suite 100

Littleton, CO 80127 USA

Phone (303) 321-1099 • Fax (303) 388-0749
goldbergbrothers.com • goldbergbartrack.com

©2020 Goldberg Brothers, Inc.