



GOLDBERG BROTHERS

BARN DOOR HARDWARE

2020 EDITION

STAINLESS STEEL SERIES CATALOG





GOLDBERG BROTHERS

BARN DOOR HARDWARE

STAINLESS STEEL SERIES CATALOG

TABLE OF CONTENTS

Hardware sets, roller hangers	2	Glass door hardware	9
Tracks	4	Pull handles, flush pulls, latches	10
Accessories	5	Installation reference guides	11
Bypass hardware	7	Warranty	15

Visit GoldbergBarnTrack.com for additional information and full installation instructions for most products.

Put your barn doors on the right track with the quality and convenience of Goldberg Brothers barn door hardware. Our award-winning products help make efficient use of any indoor living or working space. Our rustic, yet elegant, industrial design provides a bold focal point to any décor.

The Stainless Steel Series is our most contemporary and elegant barn door hardware product line. The simple and bold roller hangers and tracks are made from solid stainless steel for superior durability. A #4 brushed finish reduces reflectivity and is easily maintained. Because stainless steel is rust-resistant, this product line may be suitable for installation on covered patios or decks where there is a possibility of exposure to rain.

Goldberg Brothers products have been proudly made in USA since 1897. Our commitment to quality, craftsmanship and value is built into everything we do.

STAINLESS STEEL SERIES: HARDWARE SETS, ROLLER HANGERS

Straight Strap Hardware Set (complete less track)

weight limit 400 lb



for 1 3/8" thick door	60053H
for 1 1/4" thick door	60054H
for 2 1/4" thick door	60055H

Set includes:

- 2 straight strap hangers with bolts and caps
- wall mounting hardware set (6 lag bolts, spacers and washers)
- 2 track stops
- 2 anti-jump blocks with screws
- floor guide (T) with screws
- felt pads

Straight Top Mount Hardware Set (complete less track)

weight limit 100 lb



for most common door sizes	60050H
----------------------------	--------

Set includes:

- 2 top mount door hangers with screws
- wall mounting hardware set (6 lag bolts, spacers and washers)
- 2 track stops
- 2 anti-jump blocks with screws
- floor guide (T) with screws
- felt pads

Straight Strap Roller Hanger (1 each, with bolts and caps)

1 1/2" 10 1/4" x 1 3/8"



for 1 3/8" thick door	60053R
for 1 1/4" thick door	60054R
for 2 1/4" thick door	60055R

Straight Top Mount Roller Hanger (1 each, with screws)

4 1/2" 4 3/4" x 1 1/2"

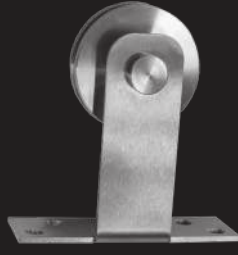

for most common door sizes	60050R
----------------------------	--------

J Strap Hardware Set (complete less track)

weight limit 400 lb



for 1 3/8" thick door	60053HJ
for 1 1/4" thick door	60054HJ
for 2 1/4" thick door	60055HJ

Set includes:

- 2 straight strap hangers with bolts and caps
- wall mounting hardware set (6 lag bolts, spacers and washers)
- 2 track stops
- 2 anti-jump blocks with screws
- floor guide (T) with screws
- felt pads

J Top Mount Hardware Set (complete less track)

weight limit 100 lb



for most common door sizes	60050HJ
----------------------------	---------

Set includes:

- 2 top mount door hangers with screws
- wall mounting hardware set (6 lag bolts, spacers and washers)
- 2 track stops
- 2 anti-jump blocks with screws
- floor guide (T) with screws
- felt pads

STAINLESS STEEL SERIES: HARDWARE SETS, ROLLER HANGERS

J Strap Hanger (1 each, with bolts and caps)

1½" 10¼" × 1⅜"



for 1⅜" thick door	60053RJ
for 1¾" thick door	60054RJ
for 2¼" thick door	60055RJ

J Top Mount Roller Hanger (1 each, with screws)

4½" 4¾" × 1½"

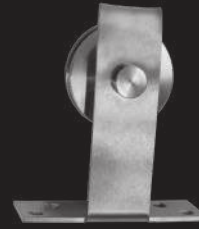

for most common door sizes	60050RJ
----------------------------	---------

Flattop Strap Hardware Set (complete less track)

weight limit 400 lb



for 1⅜" thick door	60053HFT
for 1¾" thick door	60054HFT
for 2¼" thick door	60055HFT

Set includes:

- 2 straight strap hangers with bolts and caps
- wall mounting hardware set (6 lag bolts, spacers and washers)
- 2 track stops
- 2 anti-jump blocks with screws
- floor guide (T) with screws
- felt pads

Flattop Top Mount Hardware Set (complete less track)

weight limit 100 lb



for most common door sizes	60050HFT
----------------------------	----------

Set includes:

- 2 top mount door hangers with screws
- wall mounting hardware set (6 lag bolts, spacers and washers)
- 2 track stops
- 2 anti-jump blocks with screws
- floor guide (T) with screws
- felt pads

Flattop Strap Roller Hanger (1 each, with bolts and caps)

1½" 10¼" × 1⅜"



for 1⅜" thick door	60053RFT
for 1¾" thick door	60054RFT
for 2¼" thick door	60055RFT

Flattop Top Mount Roller Hanger (1 each, with screws)

4½" 4¾" × 1½"

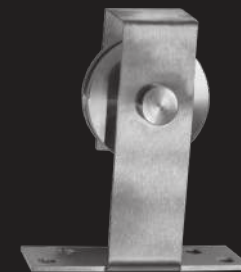

for most common door sizes	60050RFT
----------------------------	----------

STAINLESS STEEL SERIES: HARDWARE SETS, ROLLER HANGERS, TRACKS

Soft Corner Strap Hardware Set (complete less track)



for 1 1/8" thick door	60053HSC
for 1 3/8" thick door	60054HSC
for 2 1/4" thick door	60055HSC

- Set includes:
- 2 straight strap hangers with bolts and caps
 - wall mounting hardware set (6 lag bolts, spacers and washers)
 - 2 track stops
 - 2 anti-jump blocks with screws
 - floor guide (T) with screws
 - felt pads

Soft Corner Strap Roller Hanger (1 each, with bolts and caps)

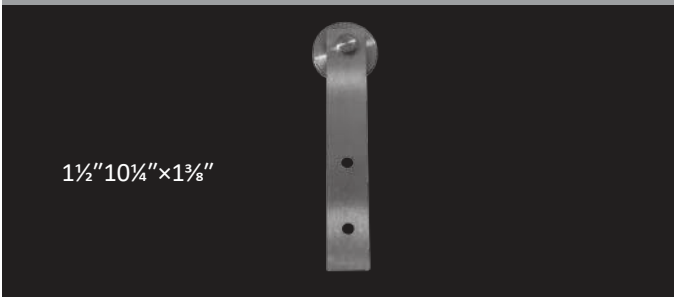

for 1 1/8" thick door	60053RSC
for 1 3/8" thick door	60054RSC
for 2 1/4" thick door	60055RSC

Delrin® Silent Rollers (1 pair, acetal resin, black)



6001SR6

Available as a factory-installed substitution for steel rollers. Recommended for doors weighing 200 lb or less.

Soft Corner Top Mount Hardware Set (complete less track)



for most common door sizes	60050HSC
----------------------------	----------

- Set includes:
- 2 top mount door hangers with screws
 - wall mounting hardware set (6 lag bolts, spacers and washers)
 - 2 track stops
 - 2 anti-jump blocks with screws
 - floor guide (T) with screws
 - felt pads

Soft Corner Top Mount Roller Hanger (1 each, with screws)

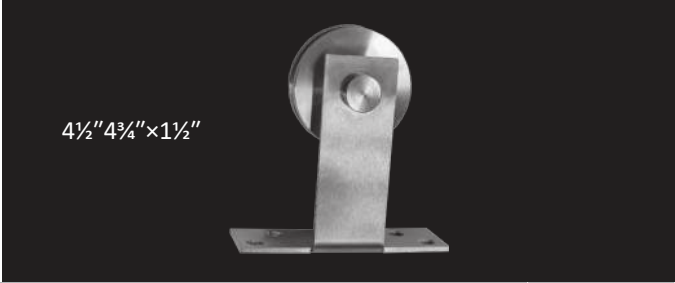

for most common door sizes	60050RSC
----------------------------	----------

Flat Track (bar only)

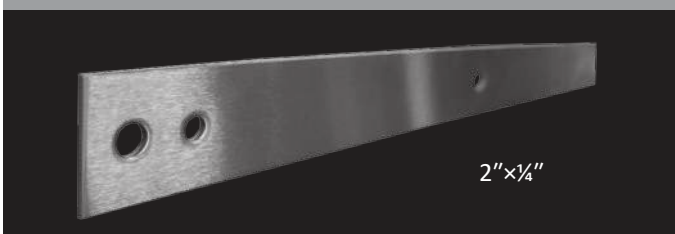

4' (for 2'0" wide door)	6005T4	
5' (for 2'6" wide door)	6005T5	
5'4" (for 2'8" wide door)	6005T54	
6' (for 3'0" wide door)	6005T6	
7' (for 3'6" wide door)	6005T7	
8' (for 4'0" wide door)	6005T8	
Biparting 6' (for pair of 1'6" wide doors)	6005T6P	
Biparting 8' (for pair of 2'0" wide doors)	6005T8P	
Long lengths	8'1" to 10'	6005T100
	10'1" to 16'	6005T160
Custom cut service (Order a standard track length longer than what you need. We will cut it down to the correct size for you.)	1 to 5 pieces	6001CCT1
	6 to 11 pieces	6001CCT2
	12 or more pieces	6001CCT4

STAINLESS STEEL SERIES: ACCESSORIES

Soft Stop (set of 2 with triggers and screws)

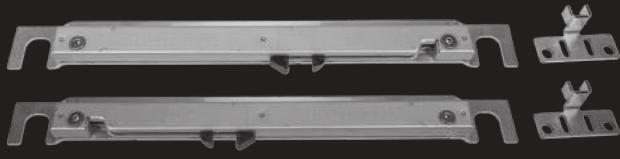

11" between center points of lag bolts (for tracks up to 7')	6005SOFT11
17" between center points of lag bolts (for tracks 8'+)	6005SOFT17
Custom length	6005SOFTCL

Soft Stop motion buffering devices slow down the door and hold it in place when opening or closing. Sold in pairs for mounting on both ends of a track.

Wall Mounting Hardware (set of 6 bolts, washers, spacers)



for 1 3/8" thick door	3 1/2" bolts	60053M
for 1 3/4" thick door	4" bolts	60054M
for 2 1/4" thick door	4 1/4" bolts	60055M

Track Extension Kit 1/2" (set of 6 bolts and spacers)



for 1 3/8" thick door	4" bolts	60053E
for 1 3/4" thick door	4 1/2" bolts	60054E
for 2 1/4" thick door	5" bolts	60055E

Track Extension Kit 7/8" (set of 6 bolts and spacers)



for 1 3/8" thick door	4 1/2" bolts	60053EX
for 1 3/4" thick door	5" bolts	60054EX
for 2 1/4" thick door	6" bolts	60055EX

Track Extension Kit 1 1/4" (set of 6 bolts and spacers)



for 1 3/8" thick door	5" bolts	60053EXX
for 1 3/4" thick door	6" bolts	60054EXX
for 2 1/4" thick door	7" bolts	60055EXX

Track Connecting Plate (1 each)

3" x 1 1/2"



6005C

Connects two shorter tracks to function as one longer track. Not required for biparting doors.

Track Lag Cover Caps (set of 6 with screws and installation tool)

1" dia. each



6005LCC

Track Stop (1 each)

3/4" x 7/8"



6005S

STAINLESS STEEL SERIES: ACCESSORIES

Floor Guide (T) (1 each, with screws, aluminum)

1½"×1½"×1"



6005G

Floor T Guide 24" (1 each, with screws, aluminum)

1½"×24"×1"

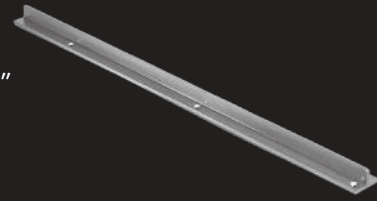

6005G2

Adjustable U-Guide (2 pieces, with screws)

7⁄8"×1"×1½" each

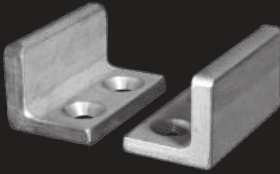

6005U

Sidewall Bracket (1 each, with screws and nuts)

1½"×2"×2"



standard	1½"×2"×2"	(stainless steel)	6005SW
long	1½"×2"×2½"	(stainless steel)	6005SWE
extra long	1½"×2"×3¼"	(stainless steel)	6005SWEX

All-in-One Floor Guide (1 each, with screws)



6005GA

Hanger Stabilizer (Set of 2, with screws)

2¼"×1⅞" each



6005HS

Track Support Z-Brackets (set of 2, with lag bolts)

1¼"×4½"×2" each

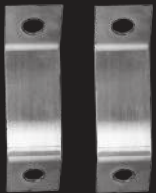

6005TZ

Hollow-Core Plates (set of 2)

2"×6⅞" each

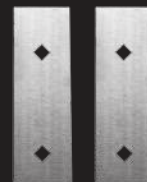

6005HCP

Anti-Jump Blocks (clear acrylic, set of 2 with screws and felt pads)

1"×2"×¼" each

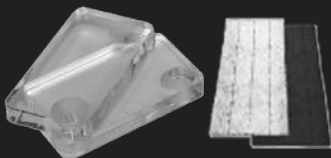

6001J

Hanger Bolts Installation Template (1 each)

6½"×6½"×¼"

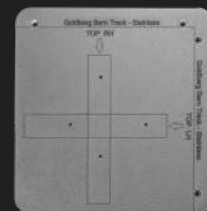

6005TMP-1

STAINLESS STEEL SERIES: BYPASS HARDWARE

Straight Strap Bypass Hardware Set (complete less track)



for 1 3/8" thick door	60053HX
for 1 3/4" thick door	60054HX
for 2 1/4" thick door	60055HX

- Set includes:
- 2 straight strap bypass hangers with bolts and caps
 - wall mounting hardware set (6 lag bolts, spacers and washers)
 - 3 bypass grab/push stops with screws
 - bypass J guide with screws
 - felt pads

J Strap Bypass Hardware Set (complete less track)



for 1 3/8" thick door	60053HXJ
for 1 3/4" thick door	60054HXJ
for 2 1/4" thick door	60055HXJ

- Set includes:
- 2 J strap bypass hangers with bolts and caps
 - wall mounting hardware set (6 lag bolts, spacers and washers)
 - 3 bypass grab/push stops with screws
 - bypass J guide with screws
 - felt pads

Straight Strap Bypass Roller Hanger (1 each, with bolts and caps)

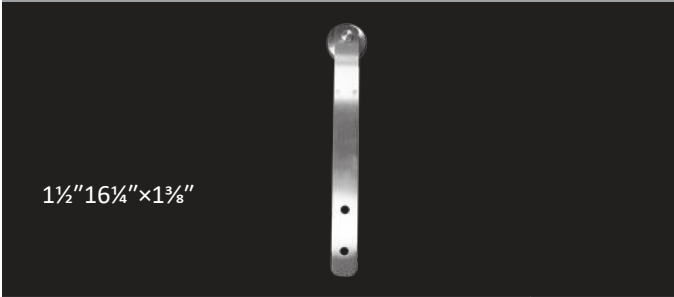

for 1 3/8" thick door	60053RX
for 1 3/4" thick door	60054RX
for 2 1/4" thick door	60055RX

J Strap Bypass Roller Hanger (1 each, with bolts and caps)

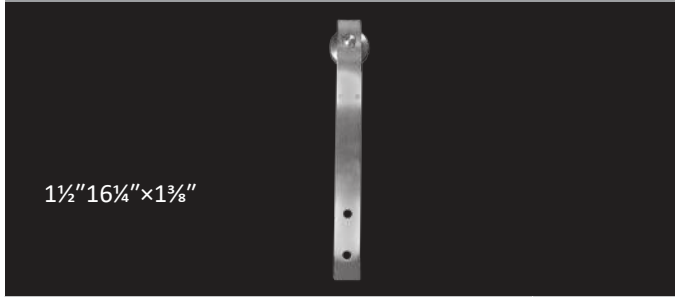

for 1 3/8" thick door	60053RXJ
for 1 3/4" thick door	60054RXJ
for 2 1/4" thick door	60055RXJ

Flattop Strap Bypass Hardware Set (complete less track)



for 1 3/8" thick door	60053HXFT
for 1 3/4" thick door	60054HXFT
for 2 1/4" thick door	60055HXFT

- Set includes:
- 2 straight strap bypass hangers with bolts and caps
 - wall mounting hardware set (6 lag bolts, spacers and washers)
 - 3 bypass grab/push stops with screws
 - bypass J guide with screws
 - felt pads

Soft Corner Strap Bypass Hardware Set (complete less track)



for 1 3/8" thick door	60053HXSC
for 1 3/4" thick door	60054HXSC
for 2 1/4" thick door	60055HXSC

- Set includes:
- 2 soft corner strap bypass hangers with bolts and caps
 - wall mounting hardware set (6 lag bolts, spacers and washers)
 - 3 bypass grab/push stops with screws
 - bypass J guide with screws
 - felt pads

STAINLESS STEEL SERIES: BYPASS HARDWARE

Flattop Bypass Roller Hanger (1 each, with bolts and caps)

1½"×16¼"×1⅜"



for 1⅝" thick door	60053RXFT
for 1¾" thick door	60054RXFT
for 2¼" thick door	60055RXFT

Soft Corner Bypass Roller Hanger (1 each, with bolts and caps)

1½"×16¼"×1⅜"



for 1⅝" thick door	60053RXSC
for 1¾" thick door	60054RXSC
for 2¼" thick door	60055RXSC

Bypass Spacer Kit - no soffit

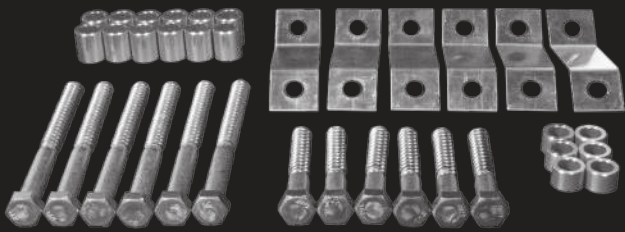

for 1⅝" thick door	60053MX
for 1¾" thick door	60054MX
for 2¼" thick door	60055MX

Bypass J Guide (1 each, with screws)

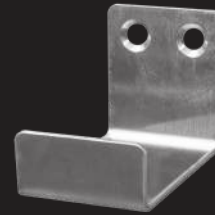

for 1⅝" thick door	1½"×1¼"×1⅛"	60053GX
for 1¾" thick door	1½"×1¼"×1⅛"	60054GX
for 2¼" thick door	1½"×1¼"×2⅛"	60055GX

Bypass Grab/Push Stops (set of 3, with screws)

1½"×¾"×¾" each

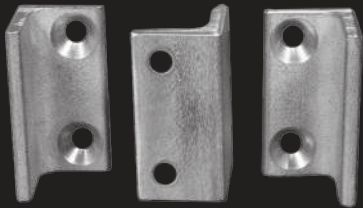

for 1⅝" thick door	6005PSX
--------------------	---------

Bypass Anti-Jump Blocks (set of 2, with nuts)

1½"×¾"×¾" each

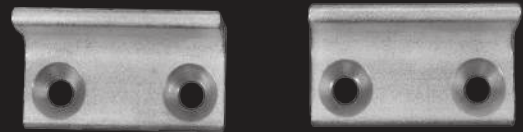

for 1⅝" thick door	6005JX
--------------------	--------

STAINLESS STEEL SERIES: GLASS DOOR HARDWARE

Glass Door Straight Strap Hardware Set (complete less track)



for $\frac{3}{8}$ " or $\frac{1}{2}$ " thick glass door

6005GH

Set includes:

- 2 straight strap hangers with bushings, spacers, bolts and caps
- wall mounting hardware set (6 lag bolts, spacers and washers)
- 2 track stops
- 4 anti-jump blocks
- adjustable U guide with screws
- felt pads

Glass Door J Strap Hardware Set (complete less track)



for $\frac{3}{8}$ " or $\frac{1}{2}$ " thick glass door

6005GHJ

Set includes:

- 2 J strap hangers with bushings, spacers, bolts and caps
- wall mounting hardware set (6 lag bolts, spacers and washers)
- 2 track stops
- 4 anti-jump blocks
- adjustable U guide with screws
- felt pads

Glass Door Flattop Hardware Set (complete less track)

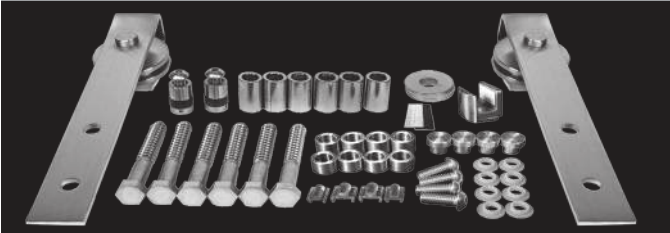

for $\frac{3}{8}$ " or $\frac{1}{2}$ " thick glass door

6005GHFT

Set includes:

- 2 flattop strap hangers with bushings, spacers, bolts and caps
- wall mounting hardware set (6 lag bolts, spacers and washers)
- 2 track stops
- 4 anti-jump blocks
- adjustable U guide with screws
- felt pads

Glass Door Soft Corner Hardware Set (complete less track)

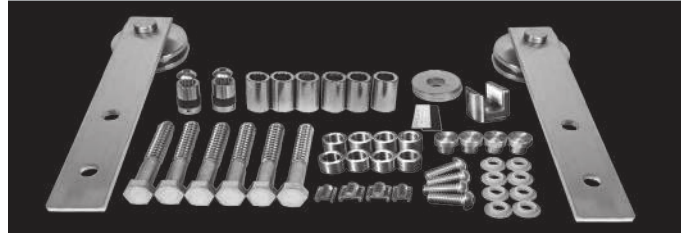

for $\frac{3}{8}$ " or $\frac{1}{2}$ " thick glass door

6005GH

Set includes:

- 2 soft corner strap hangers with bushings, spacers, bolts and caps
- wall mounting hardware set (6 lag bolts, spacers and washers)
- 2 track stops
- 4 anti-jump blocks
- adjustable U guide with screws
- felt pads

Glass Door Handle Adapter Kit (4 pieces, handle not included)

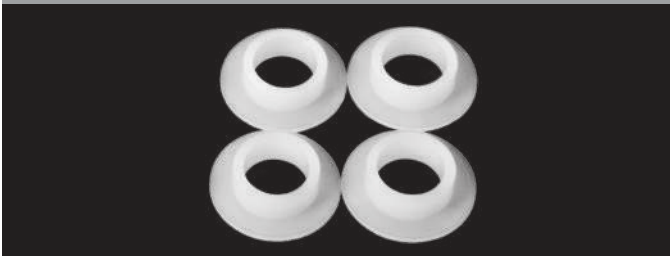

6005GPHA

Sidewall Bracket for glass doors (1 each, with screws)



6005SWG

Adjustable U Guide for glass doors (1 each, with screws and pads)

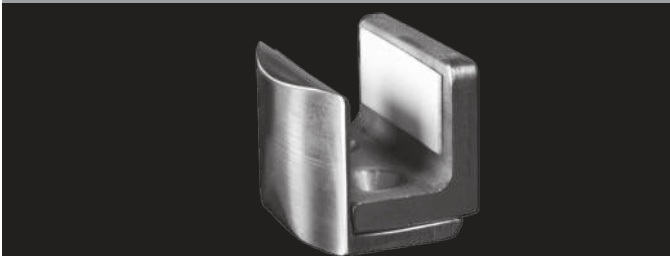

6005UG

STAINLESS STEEL SERIES: PULL HANDLES, FLUSH PULLS, LATCHES

7" Pull Handle (1 each, with bolts, washers and caps)

See page 14 for dimensions



for 1 3/8" thick door	6005PH307
for 1 3/4" thick door	6005PH407
for 2 1/4" thick door	6005PH507
Universal (fits all 3)	6005PH007

16" Pull Handle (1 each, with bolts, washers and caps)

See page 14 for dimensions



for 1 3/8" thick door	6005PH316
for 1 3/4" thick door	6005PH416
for 2 1/4" thick door	6005PH516
Universal (fits all 3)	6005PH016

11" Pull Handle (1 each, with bolts, washers and caps)

See page 14 for dimensions



for 1 3/8" thick door	6005PH311
for 1 3/4" thick door	6005PH411
for 2 1/4" thick door	6005PH511
Universal (fits all 3)	6005PH011

Router Templates (set of 3, clear plastic)



flush pulls and privacy latch templates 6001TMP-2

6" Flush Pull (1 each, with faceplate, dustbox and screws)

See page 13 for dimensions



6005FP06

12" Flush Pull (1 each, with faceplate, dustbox and screws)

See page 13 for dimensions

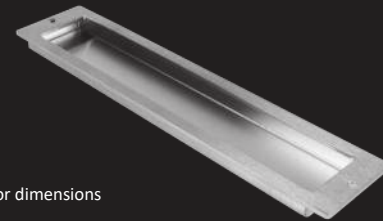

6005FP12

Privacy Latch (1 each, with faceplate, dustbox, strike plate and screws)

See page 13 for dimensions



6005PL



Biparting Privacy Latch (1 set, with screws)

See page 14 for dimensions



6005PLP

Standard System Layouts

 T-guide location (floor mount)
 Connecting plate (track mount)
 Note: the use and position of connecting plates may vary, depending on track lengths

single door



1 standard hardware set, 1 track = 2× the door width

single door larger than 4'



1 standard hardware set, 2 or 3 tracks = 2× the door width, connecting plate(s), extra wall mount kit(s)

pair of biparting doors

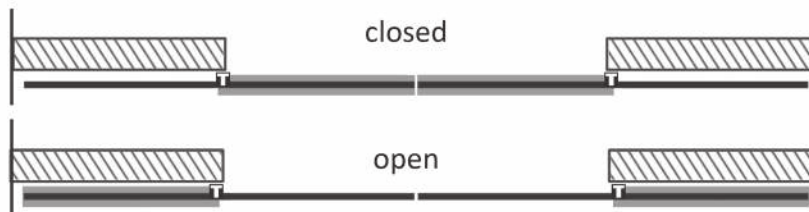

2 standard hardware sets, 2 tracks each 2× the door width, no connecting plate needed

pair of biparting doors larger than 4' each

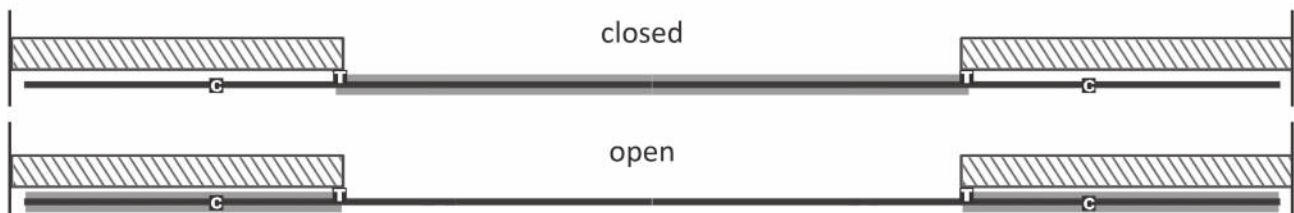

2 standard hardware sets, 4 or 6 tracks each = 2× the door width, connecting plate(s), extra wall mounting kit(s)

Bypass System Layouts

2-door system, clear opening

- ▣ T-guide location (floor mount)
- ▣ J-guide location (on back door)



1 standard hardware set, 1 track = 2× the door width, 1 bypass hardware set, 1 or 2 tracks = 3× the door width. Add connecting plate and wall mounting kit for second track if needed. Add bypass spacer kit(s) if needed.

4-door system, clear opening

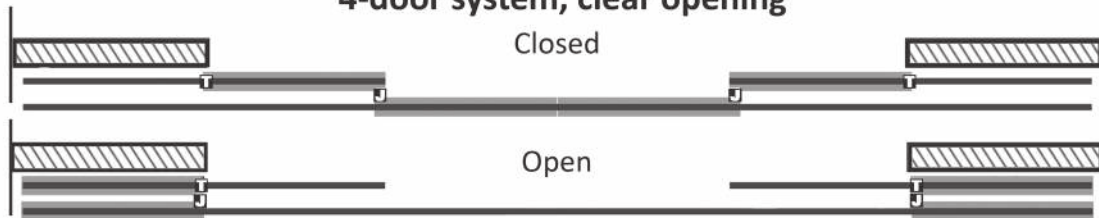

2 standard hardware sets, 2 tracks = 2× the door width, 2 bypass hardware sets, 2 or 4 tracks = 3× the door width. Add connection plate and wall mounting kit for over 2 tracks if needed. Add bypass spacer kit if needed.

2-door system, pass-through opening



1 standard hardware set, 1 bypass hardware set, 2 tracks = 2× the door width. Add 1 extra T-guide and bypass spacer kit if needed.

4-door system, pass-through opening

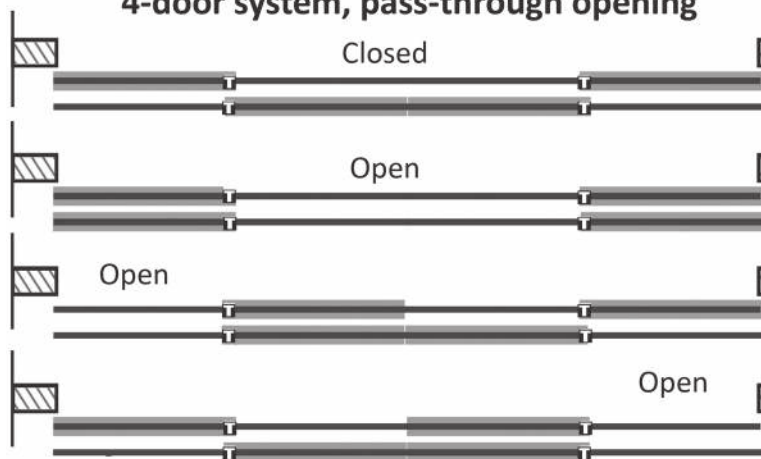

2 standard hardware sets, 2 bypass hardware sets, 4 tracks = 2× the door width. Add 2 extra T-guides and bypass spacer kits if needed.

3-door system, pass-through opening

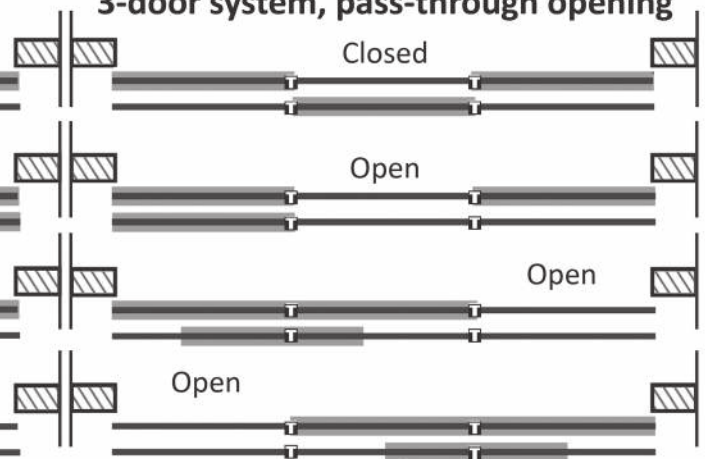

2 standard hardware sets, 1 bypass hardware set, 2 extra T-guides, 2 tracks = 3× the door width, 2 connecting plates, 1 wall mounting kit. Add bypass spacer kits if needed.

Flush Pulls

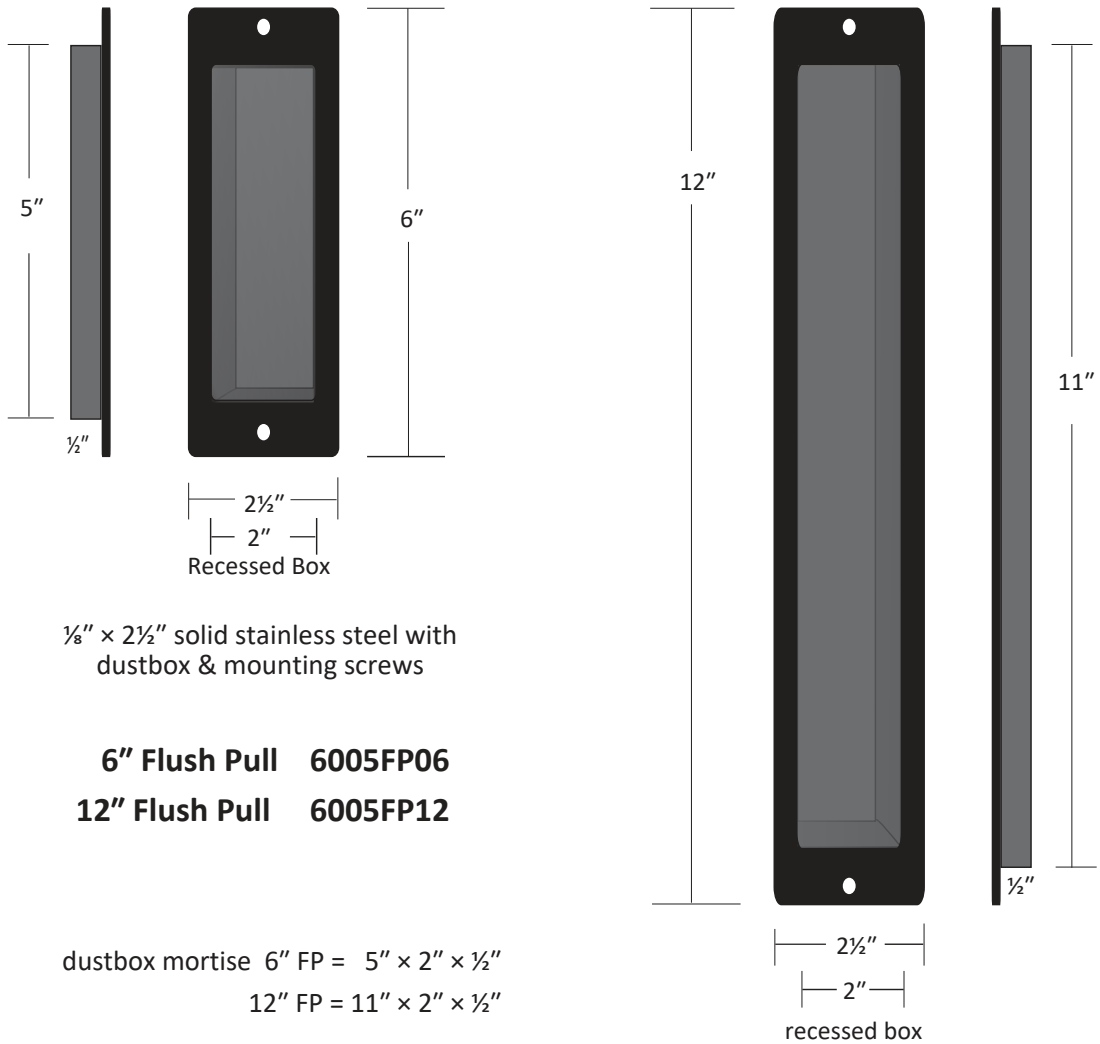

Privacy Latch

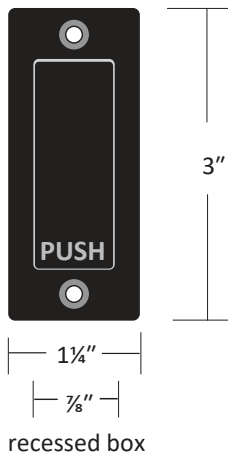

6005PL

3/16" x 1 1/4" solid stainless steel
 includes jamb strike & screws

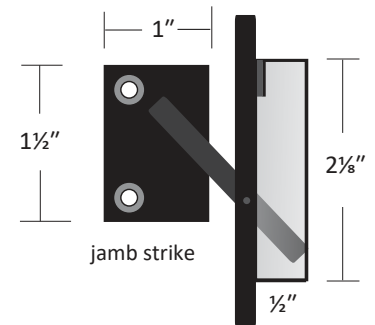

When door is on the outside of the room then the latch mounts to the door.
 When door is on the inside of the room then the latch mounts to the wall.

dustbox mortise PL = 2 1/8" x 7/8" x 1/2"

Pull Handles

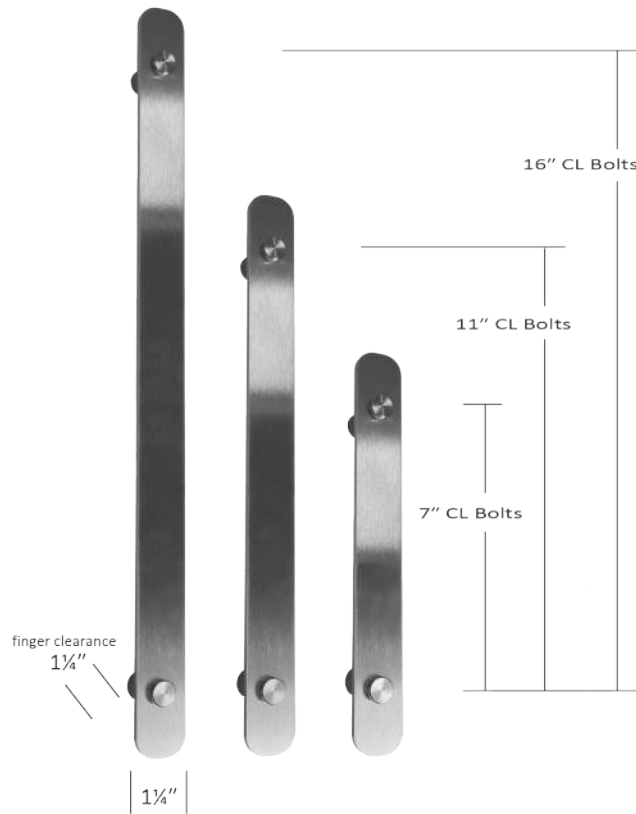

7" Pull Handle	1 $\frac{3}{8}$ " 6005PH307	1 $\frac{3}{4}$ " 6005PH407	2 $\frac{1}{4}$ " 6005PH507	Universal 6005PH007
11" Pull Handle	1 $\frac{3}{8}$ " 6005PH311	1 $\frac{3}{4}$ " 6005PH411	2 $\frac{1}{4}$ " 6005PH511	Universal 6005PH011
16" Pull Handle	1 $\frac{3}{8}$ " 6005PH316	1 $\frac{3}{4}$ " 6005PH416	2 $\frac{1}{4}$ " 6005PH516	Universal 6005PH016

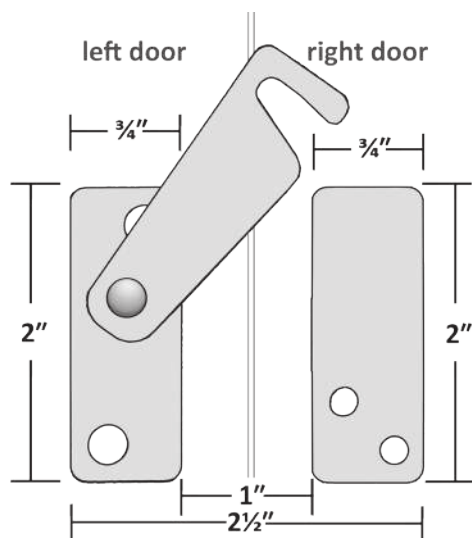

Privacy Latch for bi-parting doors

6005PLP
stainless steel
includes four mounting screws

Close doors and mount components with screwdriver while latch is in closed position.

WARRANTY

LIMITED LIFETIME MANUFACTURER'S WARRANTY

Goldberg Brothers warrants the functionality of its barn door hardware sets and tracks with a limited lifetime manufacturer's warranty for defective parts under normal installation and use. Warranty is subject to repair or replacement of defective components at manufacturer's discretion and does not include installation costs.

This warranty does not apply to the cosmetic condition of any products or components. Goldberg Brothers barn door hardware is sold as a rustic finished hardware and may develop scratches or other signs of wear during manufacturing or normal installation and use. Further, Goldberg Brothers does not warrant against any cosmetic imperfections in the steel parts that may be seen through the finish.

Certain accessories including but not limited to felt strips, rubber bumper bands, and Soft Stop motion buffer mechanisms have finite expected lifetimes due to wear and loss of tension or resilience during normal use over an extended period. Except for manufacturing defects that become apparent within 1 year of purchase, these accessories are not covered under this limited lifetime warranty. Replacement accessories may be purchased as needed from Goldberg Brothers retailers.

Except for stainless steel components, Goldberg Brothers barn door hardware products are not warranted against rust. Some rusting is possible on any raw steel or powder coated steel hardware installed outdoors or anywhere else that it may be exposed to high humidity, rain, snow, or running water.

This warranty does not include loss or defects caused by elements outside the control of Goldberg Brothers, Inc., such as natural disasters, weather, fire, water leakage, abuse, improper installation, or anything else deemed out of the control of Goldberg Brothers, Inc.



GOLDBERG BROTHERS
BARN DOOR HARDWARE

BARN DOOR EDGE WRAP

Wrap an existing door or build your own! Almost any type of wood can become a beautiful sliding door or shutter panel with Goldberg Brothers Barn Door Edge Wrap. Choose an assortment of individual boards, a set of tongue-and-groove slats, decoratively carved wood, or even a reclaimed barn wood panel. Then wrap it with our distinctive, powder-coated steel channels to create a distinctive, finishing touch to your home.

- Turns almost any wood or composite material into a finished sliding barn door
- Adds rigidity to your door to reduce warping
- Protects the edges of the door from wear and tear
- 16 powder coat colors available
- Available for door or panel thicknesses from $\frac{3}{4}$ " up to $2\frac{1}{4}$ "
- Sold in 4 common sizes up to 8'0"×8'0"
- Easy to cut down to your specific door size
- Factory-built custom sizes available by special order
- Curved door kits available by special order

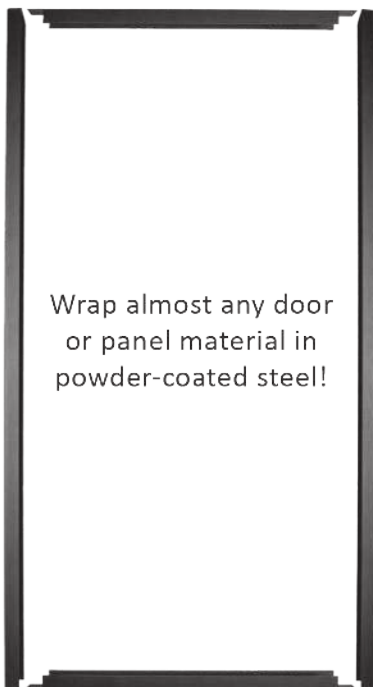

Wrap almost any door or panel material in powder-coated steel!



Adjustable U Guide for a $1\frac{1}{4}$ " to $2\frac{1}{4}$ " door

OR

Adjustable U Guide for a $\frac{3}{4}$ " to 1" door or panel

Each kit includes:

- 4 edge wrap channels
- all necessary mounting screws
- 1 adjustable U guide
- a set of shims* for use with Goldberg Brothers Standard, MP, or Shutter Series straight strap roller hangers (sold separately)

*Shims can also be used as drilling templates for mounting roller hangers to the door.

Some images are not to scale.





GOLDBERG BROTHERS, INC.

- Award-winning barn door hardware
- Barnfold® folding barn door hardware
- Barn door edge wrap
- MClad® steel cabinet facing
- Movie-themed home decor products
- Movie theater projection ports and film reels
- Custom metal fabrication

10488 W. Centennial Rd., Suite 100

Littleton, CO 80127 USA

Phone (303) 321-1099 • Fax (303) 388-0749
goldbergbrothers.com • goldbergbartrack.com

©2020 Goldberg Brothers, Inc.