



GOLDBERG BROTHERS

BARN DOOR HARDWARE

2020 EDITION

SHUTTER SERIES CATALOG





GOLDBERG BROTHERS

BARN DOOR HARDWARE

SHUTTER SERIES CATALOG

TABLE OF CONTENTS

Hardware sets, roller hangers	2	Bypass hardware	4
Tracks	2	Installation reference guides	5
Accessories	3	Warranty	6
Pull handles, flush pulls, latches	4	Color samples	inside back cover

Visit GoldbergBarnTrack.com for additional information and full installation instructions for most products.

Put your barn doors on the right track with the quality and convenience of Goldberg Brothers barn door hardware. Our award-winning products help make efficient use of any indoor living or working space. Our rustic, yet elegant, industrial design provides a bold focal point to any décor.

Our Shutter Series product line offers the superior quality of our barn door hardware in a smaller size. Shutter Series hardware sets can be used to hang indoor window shutters, of course, but they also add charm and functionality to kitchen cabinets, pantry doors, entertainment centers, bathroom cabinets, dry-erase boards, chalkboards and more. All Shutter Series hangers feature factory-installed silent rollers for smooth, reliable performance. Choose from raw steel or any of 16 powder coat colors.

Goldberg Brothers products have been proudly made in USA since 1897. Our commitment to quality, craftsmanship and value is built into everything we do.

SHUTTER SERIES: HARDWARE SETS, ROLLER HANGERS

Straight Strap Hardware Set, complete with track

weight limit 75 lb



9" panel - 18" track	6003SS18-*
12" panel - 24" track	6003SS24-*
15" panel - 30" track	6003SS30-*
18" panel - 36" track	6003SS36-*
21" panel - 42" track	6003SS42-*
24" panel - 48" track	6003SS48-*
27" panel - 54" track	6003SS54-*
30" panel - 60" track	6003SS60-*
33" panel - 66" track	6003SS66-*
36" panel - 72" track	6003SS72-*

Top Mount Hardware Set, complete with track

weight limit 75 lb



9" panel - 18" track	6003STM18-*
12" panel - 24" track	6003STM24-*
15" panel - 30" track	6003STM30-*
18" panel - 36" track	6003STM36-*
21" panel - 42" track	6003STM42-*
24" panel - 48" track	6003STM48-*
27" panel - 54" track	6003STM54-*
30" panel - 60" track	6003STM60-*
33" panel - 66" track	6003STM66-*
36" panel - 72" track	6003STM72-*

Straight Strap Hardware Set (no track)

weight limit 75 lb



6003SSH-*

Top Mount Hardware Set (no track)

weight limit 75 lb

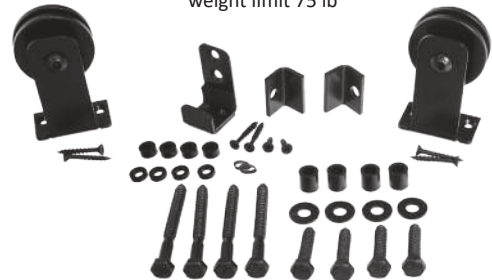

6003SST-*

Straight Strap Hanger (1 each, with bolts)

1½"×7⅞"×1¼"



6003R-*

Top Mount Hanger (1 each, with bolts)

2"×3⅝"×1¼"



6003RT-*

Replace the * in the product's SKU with the code for the desired color. See color codes on inside back cover.

SHUTTER SERIES: TRACKS, ACCESSORIES

Shutter Series Track



1 1/4" x 3/16"

9" panel - 18" track	6003T18-*
12" panel - 24" track	6003T24-*
15" panel - 30" track	6003T30-*
18" panel - 36" track	6003T36-*
21" panel - 42" track	6003T42-*
24" panel - 48" track	6003T48-*
27" panel - 54" track	6003T54-*
30" panel - 60" track	6003T60-*
33" panel - 66" track	6003T66-*
36" panel - 72" track	6003T72-*

Tracks Cut to Custom Lengths (labor only)



1 to 5 pieces up to 96"	6003CCT1
6 to 11 pieces up to 96"	6003CCT2
12+ pieces up to 96"	6003CCT3

Order a standard track length longer than what you need. We will cut it down to the correct size for you.

Wall Mounting Kit

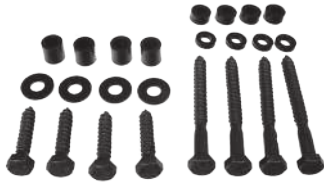

4 sets of bolts, washers, spacers (1 kit per track)	6003M-*
---	---------

1/2" Extension Kit



4 sets of bolts and spacers (1 kit per track)	6003E-*
---	---------

Track Connecting Plate

1 1/2" x 1"

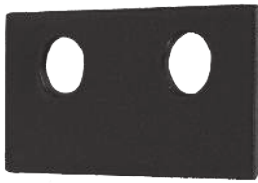

4 sets of bolts, washers, spacers (1 kit per track)	6003C-*
Not needed on standard biparting shutter sets. Use when connecting tracks on a long, single run or on bypass front tracks.	

Track Stop

3/4" x 1 1/4" x 1/2"



	6003S-*
--	---------

Adjustable Guide (with screws)

1" x 2" x variable



	6003U-*
--	---------

Touch-up Paint (1 bottle, with brush)

0.6 fl oz



	6001P-*
--	---------

Replace the * in the product's SKU with the code for the desired color. See color codes on inside back cover.

SHUTTER SERIES: ACCESSORIES, HANDLES, PULLS, LATCHES, BYPASS HARDWARE

Bumper/Stay Pads (set of 4, felt strips with adhesive back)

1" x 3/16" each strip

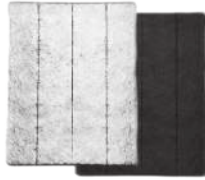

White	6001BS-1
Black	6001BS-6

Rubber Bumper Band (1 each)

1" x 3/8"



Black	6003834
-------	---------

Hanger Stabilizer (Set of 2, with screws)



2 1/4" x 7/8" each

6003HS-*

Pull Handle 4" (1 each, with bolts, washers and nuts)

See page 5 for dimensions



6003PH04-*

Flush Pull 3" (1 each, with face plate, dustbox and screws)

See page 5 for dimensions



6003FP03-*

Biparting Privacy Latch (1 set, with screws)

See page 5 for dimensions



6001PLP-*

Bypass Adapter Kit (with screws and spacers)



3/4" x 3 1/2" x 2" each

Set of 4 (1 kit per track)

6003BP-*

Bypass Bracket (with screws and spacers)

3/4" x 3 1/2" x 2"



6003BPB-*

Bypass Guide (with screws and spacers)



6003UX-*

Bypass Grab/Stop Set (with screws)



Set of 3 (1 kit per track)

6003BSX-*

Replace the * in the product's SKU with the code for the desired color. See color codes on inside back cover.

Shutter Series Pull Handles and Flush Pulls

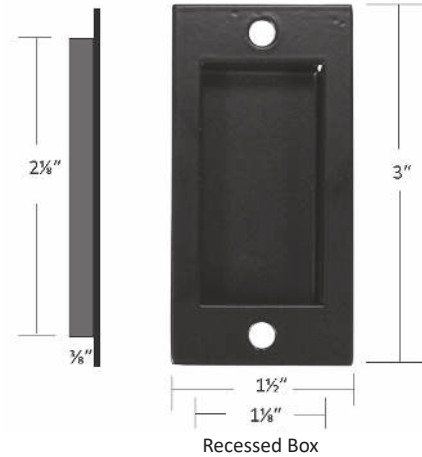
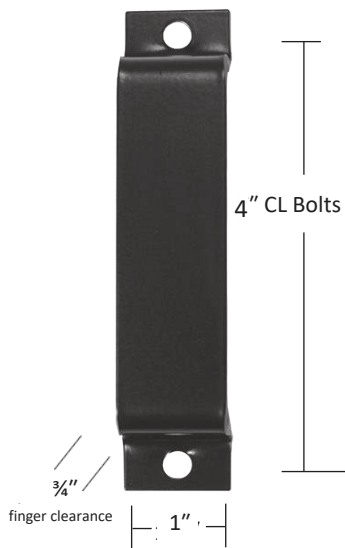

1/8" x 1 1/2" solid bar stock with
dustbox and mounting screws
dustbox mortise = 2 1/8" x 1 1/8" x 3/8"

4" Shutter Pull Handle **6003PH04-***
3" Shutter Flush Pull **6003FP03-***

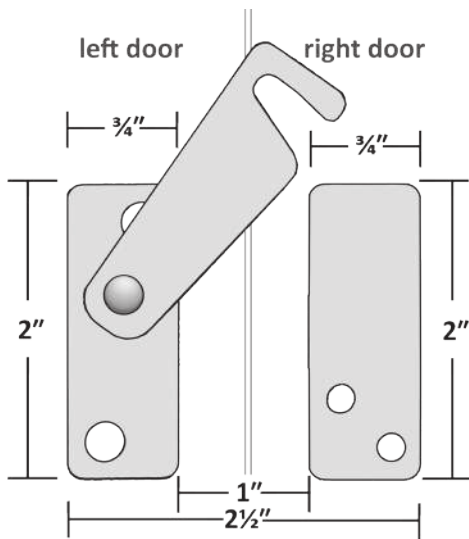

Privacy Latch for bi-parting shutters or cabinets

6001PLP-*
includes four mounting screws

Close panels and mount components with screwdriver
while latch is in closed position.

WARRANTY

LIMITED LIFETIME MANUFACTURER'S WARRANTY

Goldberg Brothers warrants the functionality of its barn door hardware sets and tracks with a limited lifetime manufacturer's warranty for defective parts under normal installation and use. Warranty is subject to repair or replacement of defective components at manufacturer's discretion and does not include installation costs.

This warranty does not apply to the cosmetic condition of any products or components. Goldberg Brothers barn door hardware is sold as a rustic finished hardware and may develop scratches or other signs of wear during manufacturing or normal installation and use. Further, Goldberg Brothers does not warrant against any cosmetic imperfections in the steel parts that may be seen through the finish.

Certain accessories including but not limited to felt strips, rubber bumper bands, and Soft Stop motion buffer mechanisms have finite expected lifetimes due to wear and loss of tension or resilience during normal use over an extended period. Except for manufacturing defects that become apparent within 1 year of purchase, these accessories are not covered under this limited lifetime warranty. Replacement accessories may be purchased as needed from Goldberg Brothers retailers.

Except for stainless steel components, Goldberg Brothers barn door hardware products are not warranted against rust. Some rusting is possible on any raw steel or powder coated steel hardware installed outdoors or anywhere else that it may be exposed to high humidity, rain, snow, or running water.

This warranty does not include loss or defects caused by elements outside the control of Goldberg Brothers, Inc., such as natural disasters, weather, fire, water leakage, abuse, improper installation, or anything else deemed out of the control of Goldberg Brothers, Inc.



GOLDBERG BROTHERS
BARN DOOR HARDWARE

EXTERIOR DUMMY ROLLER HARDWARE

Barn door hardware just for looks



Add a distinctive touch to the outside of your home with exterior Dummy Roller Series hardware from Goldberg Brothers. These powder-coated steel dummy hangers and tracks make decorative window shutters look like functional barn doors, but the dummy hangers don't actually move once installed.

- Attaches to decorative shutters and window trim
- Fits shutters up to 1½" thick
- Available with J-strap or wagon wheel dummy hangers
- Dummy hangers can be installed anywhere along the track
- Tracks sold separately in eight standard lengths from 2' to 8'
- Custom-length tracks available by special order
- Complete sets also available with track included
- No weight limit because hardware is only decorative
- Weather-resistant, zinc-coated bolts and aluminum spacers
- Available in 3 colors: matte black, silver, bronze texture

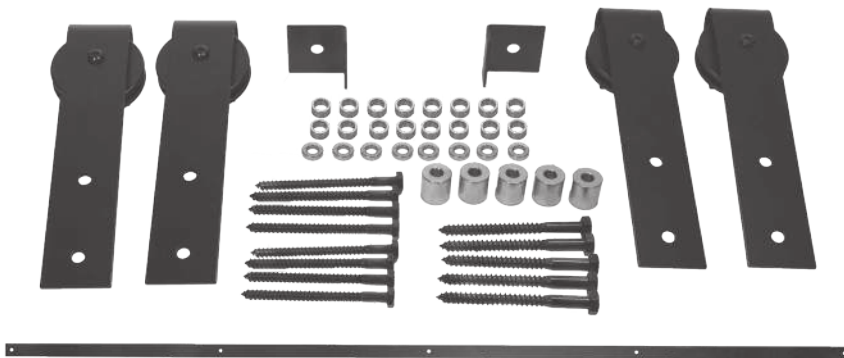

(track not to scale.)

Single-shutter complete set includes:

- 4' track
- 2 J-strap or wagon wheel dummy hangers
- 2 track stops
- All necessary bolts and spacers

Dual-shutter complete set includes:

- 8' track
- 4 J-strap or wagon wheel dummy hangers
- 2 track stops
- All necessary bolts and spacers

INTERIOR DUMMY ROLLER HARDWARE

Barn door hardware for art's sake



Mount photos, posters, paintings, mirrors, and more with interior Dummy Roller Series hardware from Goldberg Brothers. These powder-coated steel dummy hangers and tracks look like our real barn door hardware, but the hangers don't move once installed. They're a fun, attention-grabbing alternative to conventional frames.

- Attaches to most rigid, rectangular items up to 1½" thick
- Available with J-strap or wagon wheel dummy hangers
- Dummy hangers can be installed anywhere along the track
- Tracks sold separately in eight standard lengths from 2' to 8'
- Custom-length tracks available by special order
- Complete sets also available with track included
- 50 lb weight limit if item is not also fixed to wall
- Available in 16 powder coat colors or raw steel

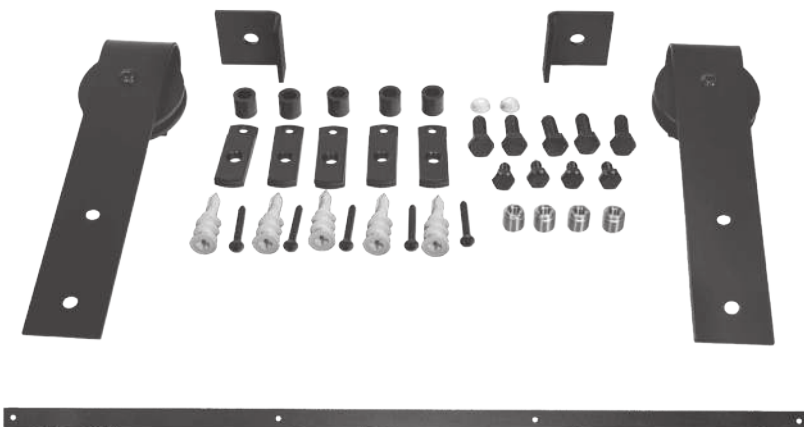









(track not to scale)







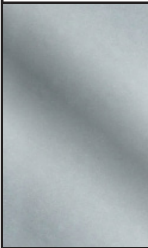

Complete set includes:

- 5' track
- 2 J-strap or wagon wheel dummy hangers
- 2 track stops
- All necessary mounting hardware

SHUTTER SERIES HARDWARE COLORS

Products with SKUs that end with a dash and asterisk -* are available in multiple colors.
 Replace the asterisk * with the desired color code.

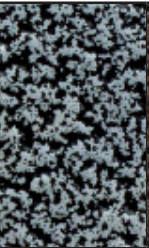
ECONOMY COLORS			STANDARD COLORS			UPGRADE COLORS	
							
RAW STEEL (not coated)	MATTE BLACK TEXTURE	BRONZE TEXTURE	BLACK	SILVER METALLIC	ARCH BRONZE	RUSTIC BROWN	JACOB'S GOLD
Color code "0"	Color code "MB"	Color code "BZ"	Color code "6"	Color code "1"	Color code "8"	Color code "4"	Color code "G"

DESIGNER COLORS								
								
PC CHROME	REGAL RED	ROCKET WHITE	BLUE RIBBON	FLINT GRAY TEXTURE	DARK GRAY TEXTURE	WHITE BRONZE TEXTURE	SILVER VEIN	COPPER VEIN

Use color code "D" and write the name of the designer color on the order form.

PLEASE NOTE:

- Due to variations in printers and display screens, all color representations above are approximate. Color sample cards are available. Ask your Goldberg Brothers sales representative for details.
- Raw steel does not have a protective coating. Rusting will occur.
- PC Chrome is a powder coat finish with a glossy, chrome-like appearance. It is not chrome plating.
- Steel components used with Matte Black Texture and Bronze Texture may have minor surface blemishes acquired during the manufacturing process. These superficial variations will be hidden by the powder coating and do not affect product performance.



GOLDBERG BROTHERS, INC.

- Award-winning barn door hardware
- Barnfold® folding barn door hardware
- Barn door edge wrap
- MClad® steel cabinet facing
- Movie-themed home decor products
- Movie theater projection ports and film reels
- Custom metal fabrication

10488 W. Centennial Rd., Suite 100

Littleton, CO 80127 USA

Phone (303) 321-1099 • Fax (303) 388-0749
goldbergbrothers.com • goldbergbartrack.com

©2020 Goldberg Brothers, Inc.